



INSPIRATION OF YOUR LIFE



Manual Book
Massage Chair FJ-5000

Contents

Before Use

Safety Precautions	1-2
Chair Components	3-4
Setting up the massage chair	5-6
Assembly	7-10
Preparation before Use	11-12

How to Use

How to Use.....	13-19
-----------------	-------

Q&A / Important Notes

Cleaning and maintenance	20
Troubleshooting	21
Grounding Instructions.....	22
Chair Specifications.....	23
FCC Radiation Exposure Statement.....	24

Thank you for purchasing this Massage Chair.
Before using your massage chair, please read the contents of this
instruction manual and refer to it when needed.

Safety Precautions

When using the massage chair, basic precautions should always be followed to reduce the risk of electric shock, burns, fire or injury to persons. Please read the following precautions before using the massage chair.

- Make sure the power plug is securely inserted into a proper electrical outlet to reduce the risk of short-circuit and fire.
- It is highly recommended that a surge protector is used to prevent from damage.
- DO NOT use the massage chair in areas where the humidity is high such as sauna steam rooms, pools, bathrooms, AC or heating vents, etc.
- DO NOT use the massage chair outdoors and avoid areas with direct sunlight.
- If the chair is not being used, turn the power switch to the OFF position and unplug the massage chair from the electrical outlet to prevent any damages to the chair when there are power outages/surges that may cause serious damage.
- Never plug/unplug the power cord plug socket with wet hands.
- Close and continuous supervision is necessary when the massage chair is used by, on or near children or disabled persons.
- No more than one person should use the massage chair at the same time.
- The massage chair is intended for use as described in the Instruction Manual. Do not use any attachments other than those recommended by the manufacturer.
- DO NOT attempt to stand or sit on the backrest, armrest or footrest in order to prevent accident, injury or damage to the chair.
- Avoid falling asleep while using the massage chair.
- Always keep the massage chair clean, and never insert any objects into or around the gaps of the massage chair.
- DO NOT move the massage chair by pulling on the power supply cord.
- Make sure there are no children, pets or other obstacles behind or underneath the massage chair.
- If you find any rips or tears in the fabric of the massage chair, contact the service department and stop using the chair immediately.
- This massage chair is designed for household use and should not be used in non-residential settings.

Safety Precautions

- Please consult your doctor if you are in doubt as to whether or not you should use this massage chair.
- Please consult a doctor before using the massage chair if you are pregnant, undergoing any medical treatment, using a medical electronic device such as a pacemaker, or are experiencing any of the following: malignant tumor, heart disease, back pain, abnormal or curved back bone, osteoporosis or acute illness.
- If you experience pain while using the massage chair, stop using the chair immediately and consult your doctor.
- Never use a massage function on swollen or inflamed parts of the body.
- DO NOT use the massage chair for more than 30 minutes at a time.
- DO NOT use the massage chair where aerosol(spray) products are being used or where oxygen is being administered.
- This massage chair is a non-professional product designed to provide a comfortable massage and should not be substituted for appropriate medical treatment.
- Never operate the appliance with the air hoses that inflate while they are blocked. Keep the air openings free of lint, hair, and any other obstructions.
- Check the skin which is in contact with the heated area of the appliance frequently to reduce the risk of injury. If the heating pad malfunctions and extreme heat is produced it may cause serious burns.
- Burns may result from improper use. If this is the case immediately shut off the chair and unplug from the outlet.
- Remove all sharp objects from the body and pockets such as keys and pens.
- Keep children away from extended foot support (or other similar parts.)
- DO NOT WET-DO NOT USE PINS.
- NEVER REMOVE COVER.

Caution

The user's weight is usually limited to 220 lbs.

For those who are weighing 220 lbs or more, the product operations may make more noise and the fabric cover may wear out faster.

Chair Components

Front

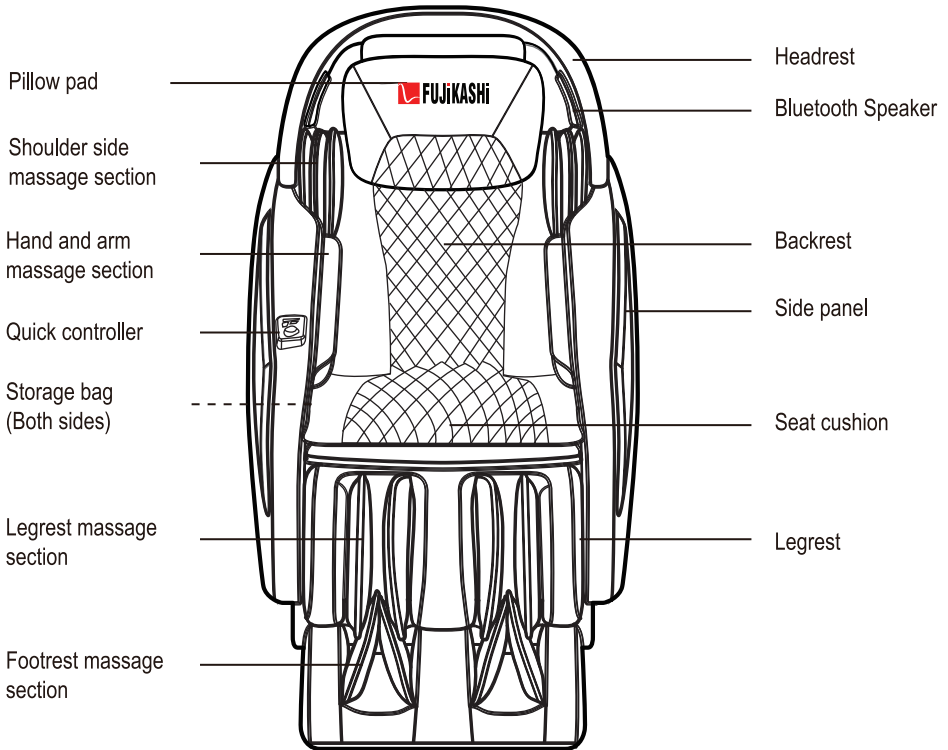

Bluetooth Speaker

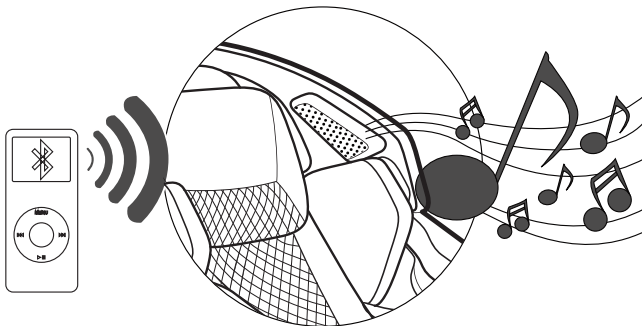

Chair Components

Air Massage Area

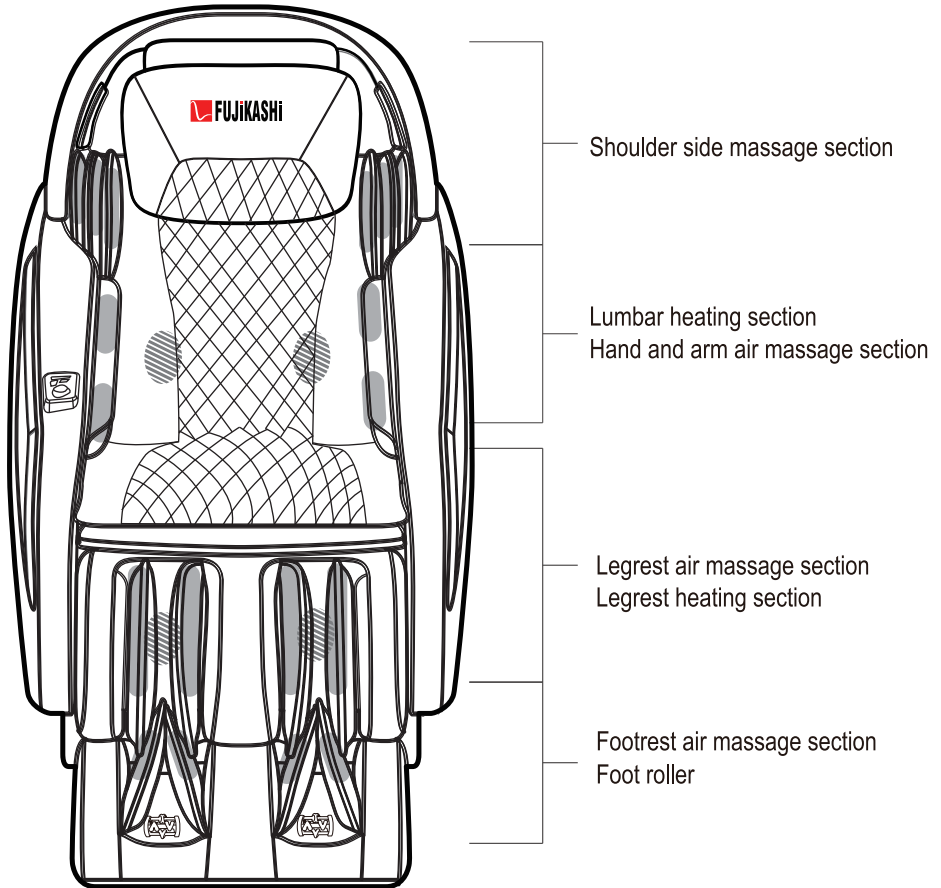

 Air bag

 Heat

 Foot Roller

Setting up the massage chair

1. Installation Position.

- Ensure there is adequate space to recline.

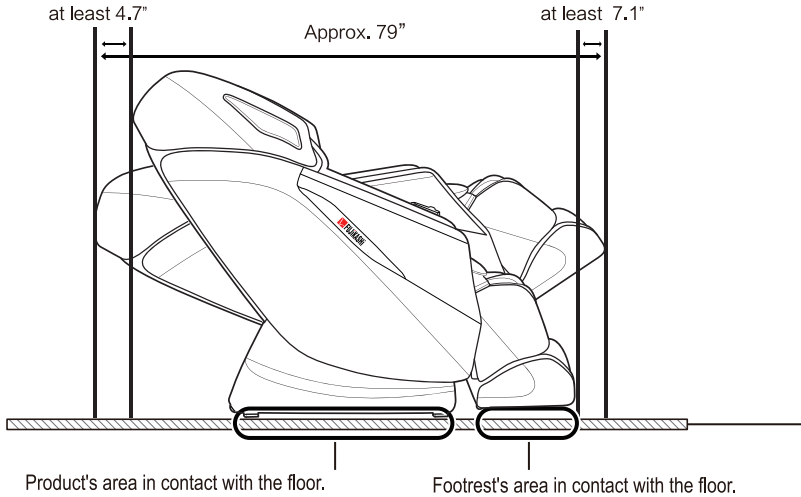

- Do not expose the massage lounger to direct sunlight or high temperatures, such as in front of heating sources, because this can cause discoloration or hardening of the synthetic leather.
- Place the unit on a mat to prevent floor damage.
- When placing a mat under the unit, the size of the mat should be sufficient (at least 52" x 32") to cover the areas where the unit touches and where the legrest could touch the floor, as shown in the diagram on the above.
- Install the unit near a power outlet.

Setting up the massage chair

2. Remove all the contents from the 3 boxes. Collect all the units and the accessories.

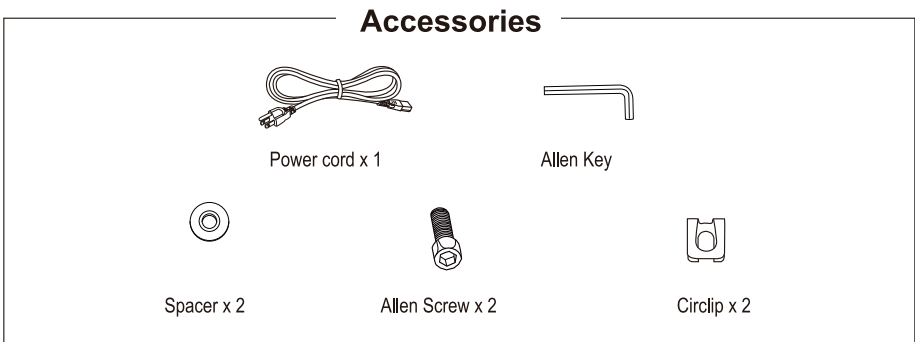
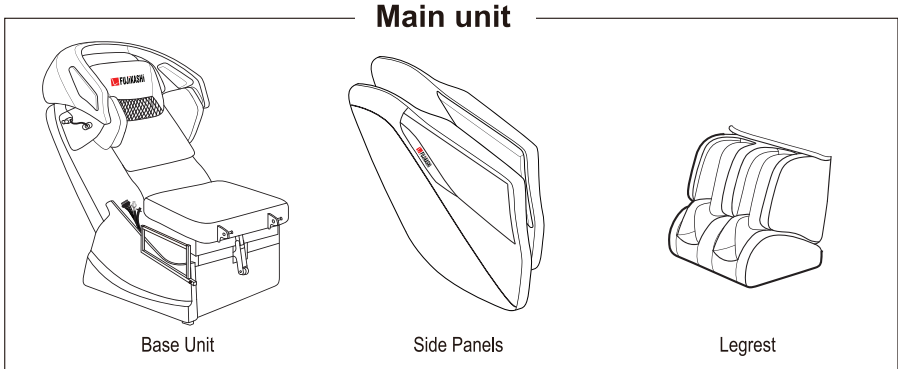

3. Plug in the power cord and turn on the power switch which will bring the chair to the upright position.

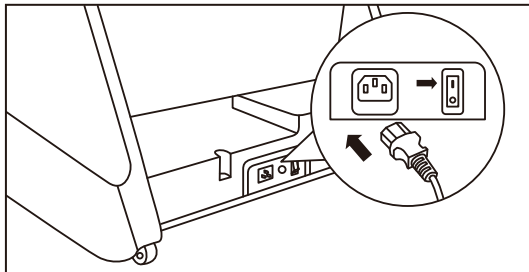

Assembly

1. Attach the side panels.

- ① Take out the right side panel and move it close to the chair.
 - ② Align and connect the air hoses C1 and C2
 - ③ LED wire: Align and connect the wire E1 to E2.
 - ④ Quick controller wire: Align and connect the wire F1 to F2
 - ⑤ Align the groove A1 and the protrusion A2. Insert A2 into A1. Insert B1 to B2.
 - ⑥ Align the D1 and D2. Fasten them with the Allen screw and Allen key provided.
-

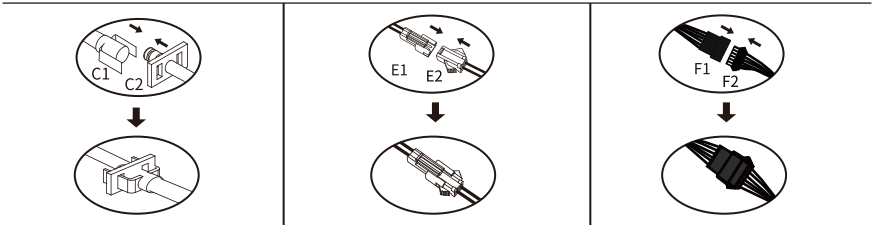
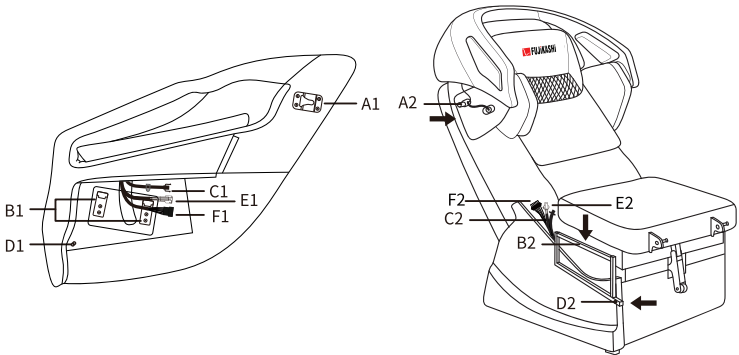

Assembly

- ⑦ Repeat the steps above to install the left side panel.
Note: There is no quick controller and wire in left side panel.
You would only need to connect the air hose and LED wire.



3. Attach the legrest.

- ① Connect all the air hoses and wires (J1 to J2, K1 to K2, L1 to L2)
- ② Align the holes H1 and shaft H2, let H2 pass through H1
- ③ Lock the shafts with the circlips provided.

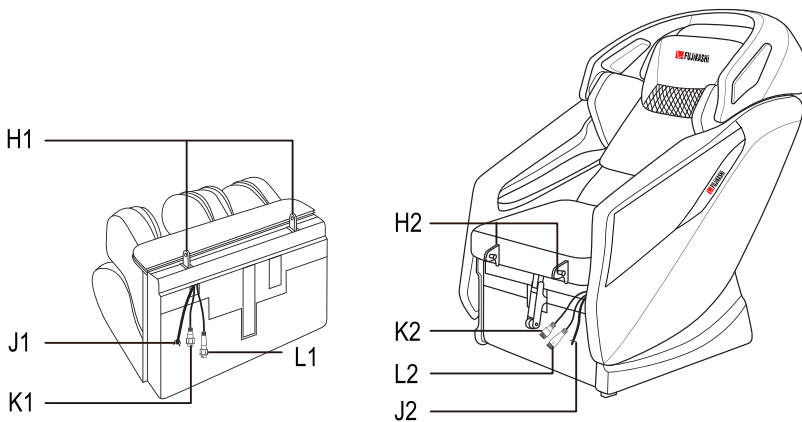

Assembly

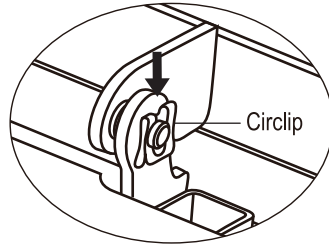
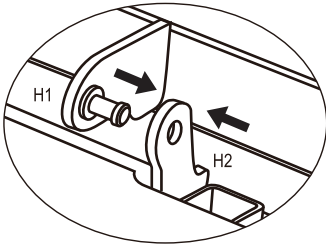
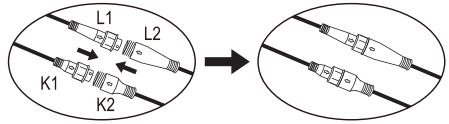
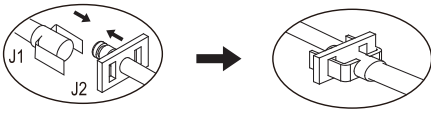

4. Attach the backrest pad.

- ① Attach the velcros on the seat side.
- ② Connect the wire M1 to M2.
- ③ Zip the zipper on the top of backrest.
- ④ Attach the velcros under the backrest and seat cushion.
- ⑤ Zip the zipper connecting legrest and seat cushion.

Assembly

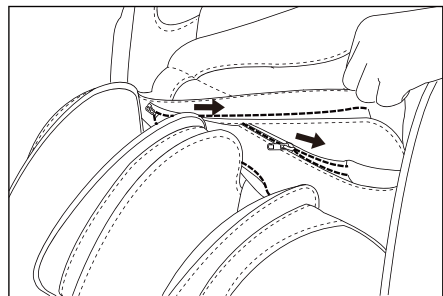
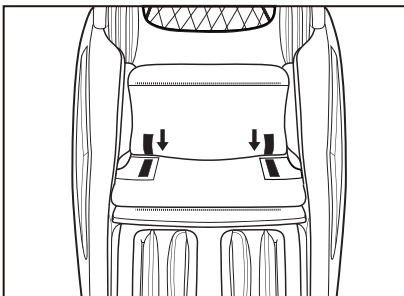
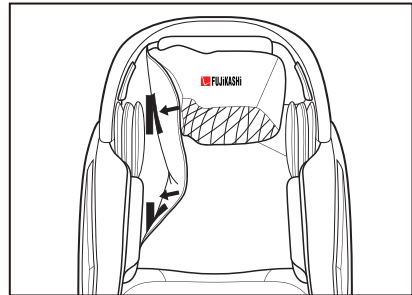
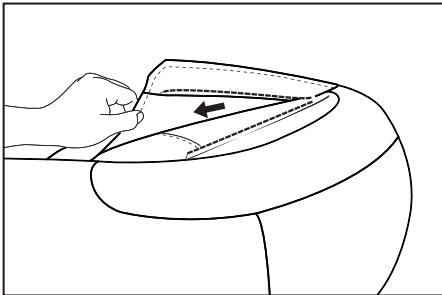
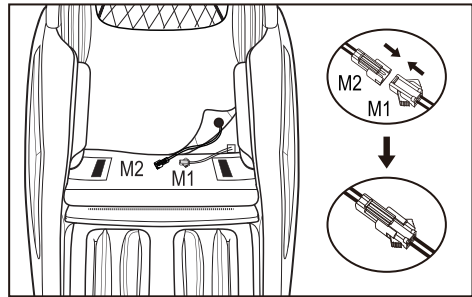
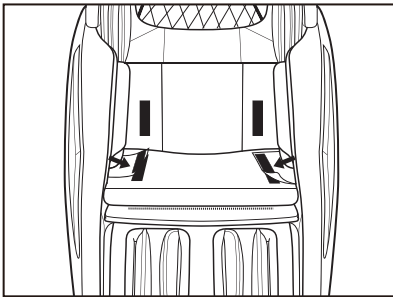

Installation completed.

Preparation before Use

1. Check the space around the product.

Make sure there is no person, pet, or other object close to the product.



2. Make sure there is no foreign matter in the seams of the product.

- Before sitting on the product, make sure there is no foreign matter between any two parts of it.
- Do not put hands, arms or head between the backrest and the back cover.
- Do not put pets on the product (such as its back cover, backrest and armrests).

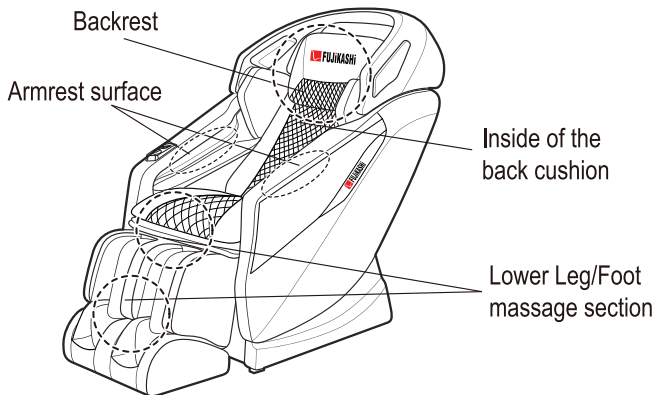

Preparation before Use

3. Power on the product

- ① Push the power connector into the appliance inlet till the end.
- ② Insert the power plug into the power outlet till the end.
- ③ Turn the switch to "I" position

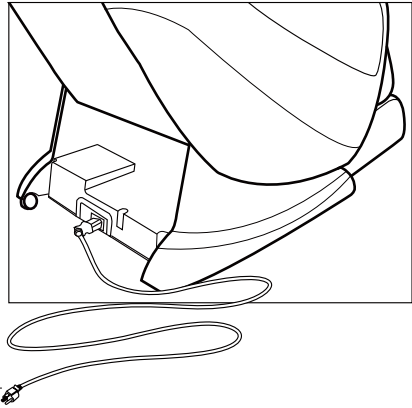
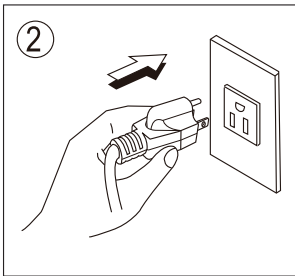
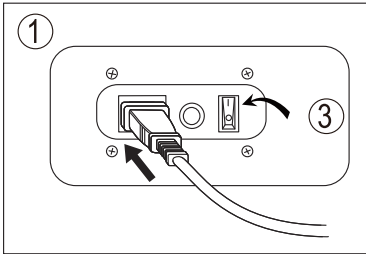

4. Make sure the massage rollers are retracted.

If they are not, press ON button to return them to the retracting position.

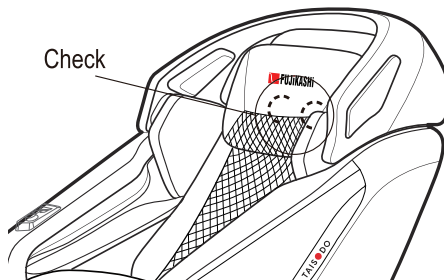

How to Use

Quick use

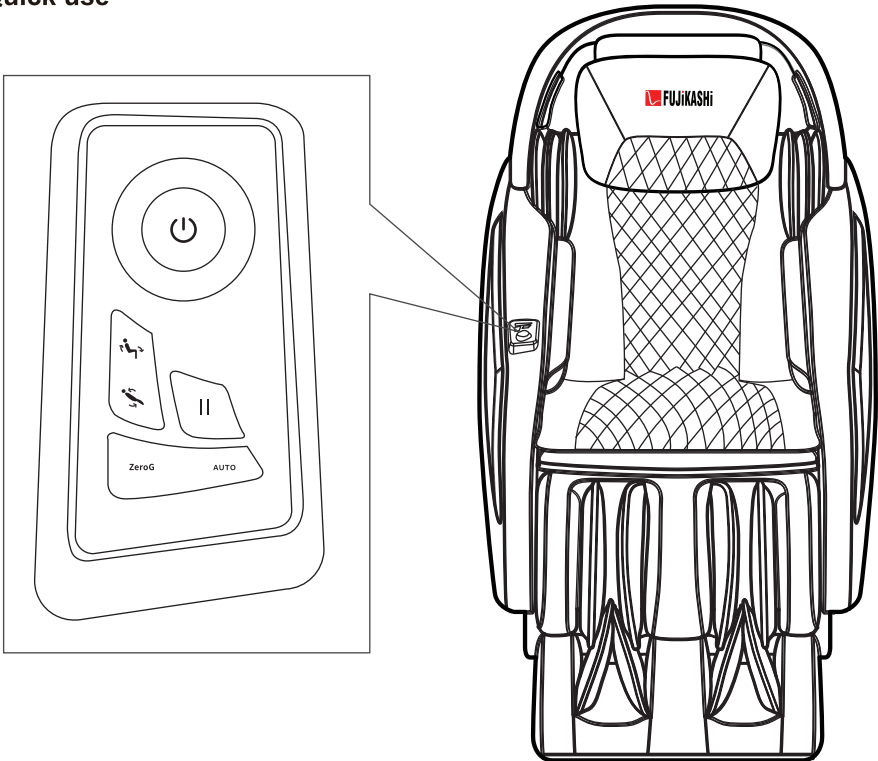

 : Press this button to start/stop the massage.

 : Press this button to pause the massage.

AUTO : Press this button to start a auto massage program.

 : Press this button to lift the chair upright.

 : Press this button to recline the chair.

ZeroG : Press this button to make the chair to Zero Gravity position.

How to Use

Controller

1. Power
2. Timer
3. Pause
4. Shoulder Position
5. Massage Rollers Up
6. Massage Rollers Down
7. Deep Tissue
8. Gentle Relief
9. Elder Care
10. Rejuvenate
11. Thai
12. Relax
13. Swing
14. Full body
15. Neck/Shoulder
16. Recovery
17. Strength +/-
18. Recline
19. Lift Upright
20. Legrest Lift
21. Legrest Drop
22. Foot Roller
23. Full Air
24. Zero Gravity



How to Use

Controller

- 25. Kneading
- 26. Tapping
- 27. Swedish
- 28. Shiatsu
- 29. Clapping
- 30. Rolling
- 31. Width
- 32. Strength
- 33. Speed
- 34. Spot
- 35. Partial
- 36. Shoulder
- 37. Arm
- 38. Legrest
- 39. Air Intensity
- 40. Calf heating
- 41. Lumbar heating



How to Use

Programs Description

1. Power

- The start/stop control button
- Press this button to turn on the power.

2. Timer

- Time interval control button.
- When a massage function is activated, the timer is preset at 15 minutes. Every single press on this button will change the timer interval in the sequence of “20 > 25 > 30 > 5 > 10 > 15 > 20” minutes in circle.
- When only one minute left, 5 beeps will be sounded to alert the user.

3. Pause

- Press this button once to halt current massage function and countdown timer. During pause mode, the pause button will be blinking.
- Press this button again to cease the “Pause” function and resume previous massage function as well as countdown timer.

4-6. Shoulder position & adjustment

- Press button “Shoulder position” to activate shoulder position and back curve detecting function. Press again to stop this function.
- Press ▲/▼ to choose position of massage rollers when a “beep” sound alerts in 10 seconds.
- Release the button once the desired position is achieved.
- Note: This function can also be used during sector massages.

Full body auto massage program

7. Deep Tissue

8. Gentle Relief

9. Elder Care

10. Rejuvenate

11. Thai

12. Relax

13. Swing (Default timer is 30 minutes. Massage for the first 15 minutes and rest for the last 15 minutes.)

14. Full body

15. Neck/Shoulder

16. Recovery

- Note: When user firstly start the auto massage program, it will scan and adjust the length of backrest automatically.

How to Use

17.Strength

- The Strength adjustment button for kneading function (5 levels available).
- Press “+” to enhance strength level till Lv5.
- Press “-” to reduce strength level till Lv1.

18/19. Recline / Lift Upright

- Press to comfortably lay flat or to restore the chair to its original position.

20/21. Legrest Lift / Drop

- Angle adjust button for legrest
- Press either button activate adjust function, press again when the legrest reaches your desired position.

22.Foot Roller

- Press this button once to activate rhythmic rolling massage at soles, press this button again to stop rolling massage at soles.
- Note: During auto program mode, pressing this button can also disable/enable the foot roller function.

23.Full Air

- Press this button to activate full body air massage function.
- Full Air intensity can be adjusted by pressing “Intensity” button respectively after activating full air function.

24.Zero Gravity

- Press this button to activate zero gravity position 1. Press again to activate zero gravity position 2. Third press will cease zero gravity function.
- Note: Zero Gravity is not available during auto program “Thai”.

Manual Selection Buttons

25.Kneading

- Kneading function Start/Stop Control Button - 5 levels of strength to be adjusted.
- Press this button to activate rhythmic mode 1 Kneading function for a full back massage at medium strength. Press the button again to activate mode 2 Kneading function.

26.Tapping

- Tapping function Start/Stop Control Button - 3 levels of width, 5 levels of speed to be adjusted.
- Press this button to activate rhythmic mode 1 Tapping function for a full back massage at medium strength. Press the button again to activate mode 2 Tapping function.

How to Use

27.Swedish

- Swedish function Start/Stop Control Button - 5 levels of speed to be adjusted.
- Press this button to activate rhythmic mode 1 Swedish function for a full back massage at medium strength. Press the button again to activate mode 2 Swedish function.

28.Shiatsu

- Shiatsu function Start/Stop Control Button - 3 levels of width, 5 levels of speed to be adjusted.
- Press this button to activate rhythmic mode 1 Shiatsu function for a full back massage at medium strength. Press the button again to activate mode 2 Shiatsu function.

29.Clapping

- Clapping function Start/Stop Control Button - 3 levels of width, 5 levels of speed to be adjusted.
- Press this button to activate rhythmic mode 1 Clapping function for a full back massage at medium strength. Press the button again to activate mode 2 Clapping function.

30.Rolling

- Rolling function Start/Stop Control Button - 3 levels of width to be adjusted.
- Press this button to activate rhythmic mode 1 Rolling function for a full back massage at medium strength. Press the button again to activate mode 2 Rolling function.

Note: This function cannot perform "Spot" massage function.

31.Width

- When Tapping, Clapping, Shiatsu or Rolling function is engage, every single press on this button will change the massage width interval in the sequence of "Narrow > Medium > Wide" in cycle.

32.Strength

- When Kneading function is engage, every single press on this button will change the massage strength interval in the sequence of "Lv1 > Lv2 > Lv3 > Lv4 > Lv5" in cycle.

33.Speed

- When Tapping, Clapping, Swedish or Shiatsu function is engage, every single press on this button will change the massage speed interval in the sequence of "Lv1 > Lv2 > Lv3 > Lv4 > Lv5" in cycle.

34.Spot

- Press this button to activate localized Spot Massage while the original massage mode continues to run at the latest position. Press again to resume full back massage function.

35.Partial

- Press this button to keep the original massage mode working within a range of 3.14". Press again to resume full back massage function.

How to Use

Setting Air Squeeze

36.Shoulder

- Press this button once to activate rhythmic air massage at shoulder. Press this button again to stop the function.

37.Arm

- Press this button once to activate rhythmic air massage at hand and arm. Press this button again to stop the function.

38.Legrest

- Press this button once to activate rhythmic air massage at calf and foot. Press this button again to stop the function.

39.Air Intensity

- When Air massage function is engaged, every single press on this button will change the air intensity in the sequence of "Lv1 > Lv2 > Lv3 > Lv4 > Lv5"

40.Calf Heating

- Press this button to activate calf heating function, press this button again to stop the calf heating function.
- Note: During auto program mode, pressing this button can also disable/enable the calf heating function.

41.Lumbar Heating

- Press this button to activate lumbar heating function, press this button again to stop the lumbar heating function.
- Note: During auto program mode, pressing this button can also disable/enable the lumbar heating function.

Cleaning and maintenance

1. Cleaning of the synthetic leather

Wipe the synthetic leather with a soft dry cloth.

- Do not clean the product with chemicals such as thinners, gasoline and alcohol.
- When using a leather maintenance product (cleaning cloth) sold on the market, follow its directions for use.
- If the synthetic leather is very dirty, wipe it with the method below.

- ① Put a piece of soft cloth into water or 3% to 5% neutral detergent contained hot water and wring it out.
- ② Wipe surface of the synthetic leather with the soft cloth.
- ③ Wipe the detergent with a piece of cloth once soaked in clean water and wrung out.
- ④ Wipe with a piece of wrung soft cloth.
- ⑤ Have the synthetic leather take natural air drying.

- If it is difficult to remove the stains on the synthetic leather, soak a piece of melamine foam bought from the market into a neutral detergent and use it wipe the product.
- Do not dry the surface by a hair drier.
- Surface of the synthetic leather may be dyed by fabric colors; therefore, be careful when wiping the product with denim or colored cloth.
- Synthetic leather may discolor, so the position in contact with the hair dye used should be covered by a towel.



2. Cleaning of the plastic parts

- 1) Put a piece of soft cloth into water or neutral detergent contained hot water, wring it out and wipe the plastic parts.

- Do not clean the product with chemicals such as thinners, gasoline and alcohol.

- 2) Wipe with a piece of cloth once soaked in clean water and wrung out.

- Wring the cloth out before using it to wipe the remote controller.

- 3) Have the plastic parts take natural air drying.



Troubleshooting

This page summarizes the most common problems you could encounter with the product. If you are unable to solve the problem with the information below, contact service center immediately.

If the problem encountered is not listed, please try the following suggestions:

1. Turn off the product and unplug it.
2. Wait for 60 minutes.
3. Plug the product back to the recommended outlet and restart.
4. If the problem persists, contact the authorized service center.

Problem	Possible Cause	Suggestion
The product does not work	The product is not plugged in properly.	Ensure the voltage on the product corresponds to the local mains voltage and then plug in again. Make sure the outlet is properly working.
The product stopped working	The product has just finished its auto timer session and has automatically switched to standby mode.	If you want another session, press the Power button again.
The product stopped working	You may have used the product continuously for 45 minutes where the over heat protection has been activated.	Unplug the product and let it cool down for 60 minutes before you use it again.
The product does not work	An excessive load has been applied on the product.	Reduce the excessive load and start again.
The product is abnormally warm	The product is likely to be overused.	Unplug the product and let it cool down before using it again.
Noise can be heard from the product	Noise is made by the mechanical parts of the product.	This is normal and does not mean that the product is faulty.

Grounding Instructions

This product must be grounded. If it should malfunction or break down, grounding provides a path of least resistance for the electric current to reduce the risk of electric shock. This product is equipped with a cord with an equipment-grounding conductor and a grounding plug. The plug must be plugged into an appropriate outlet that is properly installed and grounded in accordance with all local codes and ordinances.

Danger-Improper connection of the equipment-grounding conductor can result in a risk of electric shock. Check with a qualified electrician or service technician if the product will not fit the outlet, have a proper outlet installed by a qualified electrician.

This product is for use on a nominal 120V circuit and has grounding plug that looks like that plug illustrated below. Make sure that the product is connected to an outlet having the same configuration as the plug. No adapter should be used with this product.

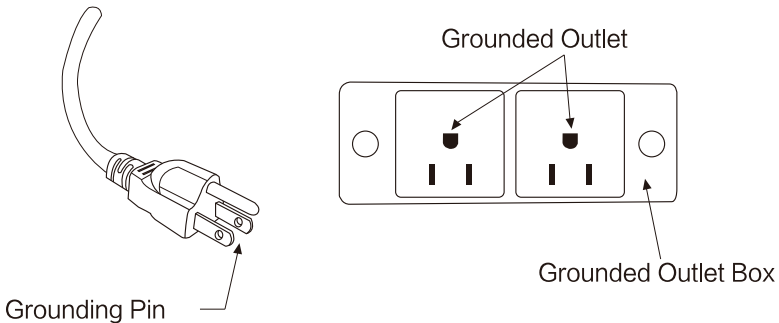

Chair Specifications

Description	Specifications
Model No.	FJ-5000
Rated Voltage	220-240V~
Rated Frequency	50 - 60Hz
Rated Power Consumption	140W
Timer	5/10/15/20/25/30 minutes
Rated Time	30 minutes
Dimensions(L x W x H)	Upright: 62.6"x33.1"x49.2"
	Reclined: 74.8"x33.1"x36.2"
Weight	Gross Weight: Approx. 264.6 lbs
	Net Weight: Approx. 216.1lbs
Length of Wire	Controller wire: 59.0"
	Power supply wire: 70.9"
Usage Condition	Environment temperature: 32°F~95°F
	Contrasting humidity: 20-80RH
Storage Condition	Storage temperature: 23°F~95°F
	Storage humidity: 20-80RH
Safety Feature	Equipped with overheated and power
Maximum body weight of user	220 lbs

FCC Radiation Exposure Statement

FCC Radiation Exposure Statement: (mobile device)

This equipment complies with FCC radiation exposure limits set forth for an uncontrolled environment. In order to avoid the possibility of exceeding the FCC radio frequency exposure limits, Human proximity to the antenna shall not be less than 20cm (8 inches) during normal operation.

FCC STATEMENT

1. This device complies with Part 15 of the FCC Rules. Operation is subject to the following two conditions:

- (1) This device may not cause harmful interference, and
- (2) This device must accept any interference received, including interference that may cause undesired operation.

2. Changes or modifications not expressly approved by the party responsible for compliance could void the user's authority to operate the equipment.

This equipment has been tested and found to comply with the limits for a Class B digital device, pursuant to part 15 of the FCC Rules. These limits are designed to provide reasonable protection against harmful interference in a residential installation. This equipment generates, uses and can radiate radio frequency energy and, if not installed and used in accordance with the instructions, may cause harmful interference to radio communications. However, there is no guarantee that interference will not occur in a particular installation. If this equipment does cause harmful interference to radio or television reception, which can be determined by turning the equipment off and on, the user is encouraged to try to correct the interference by one or more of the following measures:

- Reorient or relocate the receiving antenna.
- Increase the separation between the equipment and receiver.
- Connect the equipment into an outlet on a circuit different from that to which the receiver is connected.
- Consult the dealer or an experienced radio/ TV technician for help.

